

Microstrip-Slot Coupler Design—Part II: Practical Design Aspects

REINMUT K. HOFFMANN AND JOHANN SIEGL

Abstract—Practical aspects of designing microstrip-slot couplers on an Al_2O_3 ceramic substrate ($\epsilon_r = 9.8$) are treated in supplementation of the theoretical analysis of the coupler presented in Part I. Comparison with implemented couplers yields rules for specification of the reference planes at the ends of the coupling section and for the appropriate choice of definition for the slot-line characteristic impedance. Design data of the standard versions of the microstrip transmission line and the slot line are shown to be adequate for the microstrip-slot coupler. Computed S -parameter curves plotted for various 3-dB couplers yield information on realizable transmission characteristics.

I. INTRODUCTION

TO SUPPLEMENT the theoretical analysis presented in Part I, several problems of practical microstrip-slot coupler design are treated here. Emphasis is given to the realization of 3-dB couplers in microwave integrated circuit technology on Al_2O_3 ceramic substrate (dielectric constant $\epsilon_r = 9.8$). The configuration of this coupler is given in Fig. 1. Section II shows that the design data for the standard microstrip and slot line are good approximations for dimensioning the coupler cross section. The accuracy of the analysis in Part I is verified by a comparison with the measurement data in Section III. In addition, design parameters that still remain to be determined, such as the position of the reference planes, the definition of the slot-line characteristic impedance, and the influence of the transmission line loss are investigated. The improvement of the coupler performance attainable through compensation is shown with the aid of the theoretical analysis in Section IV.

II. SIMPLIFIED COMPUTATION OF EVEN- AND ODD-MODE PARAMETERS

The accurate computation of the characteristic impedance Z_M and effective permittivity K_M for the microstrip mode (even-mode excitation) and of the corresponding values— Z_S and K_S —for the slot mode (odd-mode excitation) of the original coupler cross section (Fig. 1(b)) requires an extensive numerical analysis, such as is described in [9]–[13] listed in Part I. In practice, such data are often not available. Analyses are, however, usually available for the standard microstrip transmission line such as those presented in [1]–[3] and for the standard slot line, which are presented in [4]–[6]. These analyses can provide useful approximate parameter values for the microstrip-slot con-

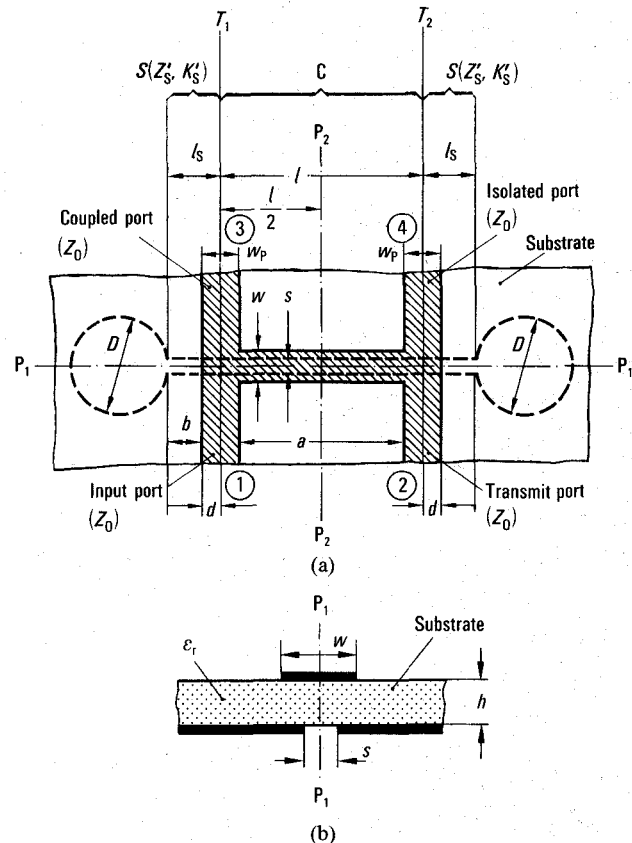

Fig. 1. Configuration of the microstrip-slot coupler. (a) Upper side of substrate. (b) Cross section.

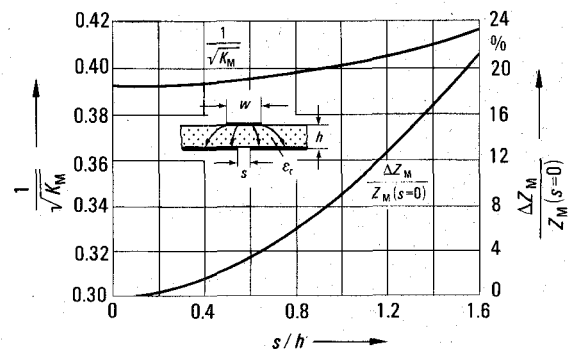

Fig. 2. Deviation of the microstrip mode parameters Z_M , K_M of the coupler cross section from the parameters of standard microstrip ($s = 0$) for $w/h = 1$, $h/\lambda_0 = 0.01$, $\epsilon_r = 9.8$. λ_0 is the free space wavelength, $\Delta Z_M = Z_M(s) - Z_M(s = 0)$.

Manuscript received July 2, 1981; revised March 17, 1982.

The authors are with the Communications Division of Siemens AG, Hofmannstrasse 51, D-8000 München 70, West Germany.

figuration. For example, Fig. 2 shows that the errors in Z_M and K_M under the assumption that the slot width $s = 0$, are

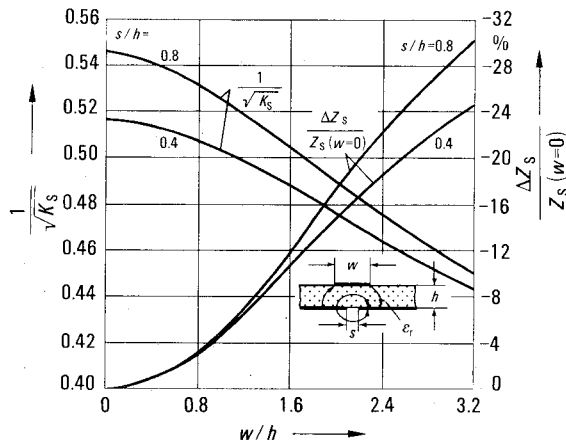

Fig. 3. Deviation of the slot-mode parameters Z_S , K_S of the coupler cross section from the parameters of standard slot line ($w=0$) for $h/\lambda_0=0.02$, $\epsilon_r=9.8$; $\Delta Z_S = Z_S(w) - Z_S(w=0)$.

negligibly small for $s/h < 0.3$. Coupling coefficients of $\lesssim 6$ dB are taken into account here. These values were computed by the method of lines [7]. Similarly, Fig. 3 shows that the errors in Z_S and K_S , under the assumption that the strip width is zero, are likewise negligibly small for $w/h < 0.8$ and $s/h < 0.4$. These values were computed by a mode-matching technique extended to cover the given configuration [8]. Thus the parameters for 3-dB microstrip-slot couplers for the conventional microwave frequency range (approximately 2–18 GHz) are covered by the approximations of the standard microstrip and slot line.

III. COMPARISON OF MEASURED AND THEORETICAL RESULTS

A. Implemented Couplers

Four microstrip-slot couplers (Table I) with a center frequency f_c in the region of 5.6 GHz were implemented on Al_2O_3 ceramic substrates using thin-film technology with 6 μm thick gold conductors (Fig. 4). All couplers are partially compensated. This means that the length l_S of the compensation slot lines S is > 0 , but that compensation condition (30) of Part I for l_S is not met. Coupler 1 is a 3-dB coupler for which the matching condition (14) of Part I is satisfied. For couplers 2, 3, and 4 the matching condition is not satisfied.

The measured frequency responses of the transmission loss $a_{21} = -20 \log |S_{21}|$ and the coupling loss $a_{31} = -20 \log |S_{31}|$ of the implemented couplers are compared with the theoretical responses in Figs. 5–7. S_{ij} are the scattering parameters of the coupler. The measured frequency responses of a_{21} and a_{31} in Figs. 5–7 refer to the whole circuit on the substrate shown in Fig. 4, and include the attenuation of 0.1 dB in all two feeding lines. The theoretical values of S_{21} , S_{31} were computed with the aid of the analysis given in Part I, with $Z'_S = Z_S$ and $Z_0 = 50 \Omega$.

B. Empirical Determination of Reference Plane Location and of Proper Slot Line Impedance Definition

For the calculation of theoretical responses of $a_{21}(f)$ and $a_{31}(f)$, as for coupler design in general, two questions

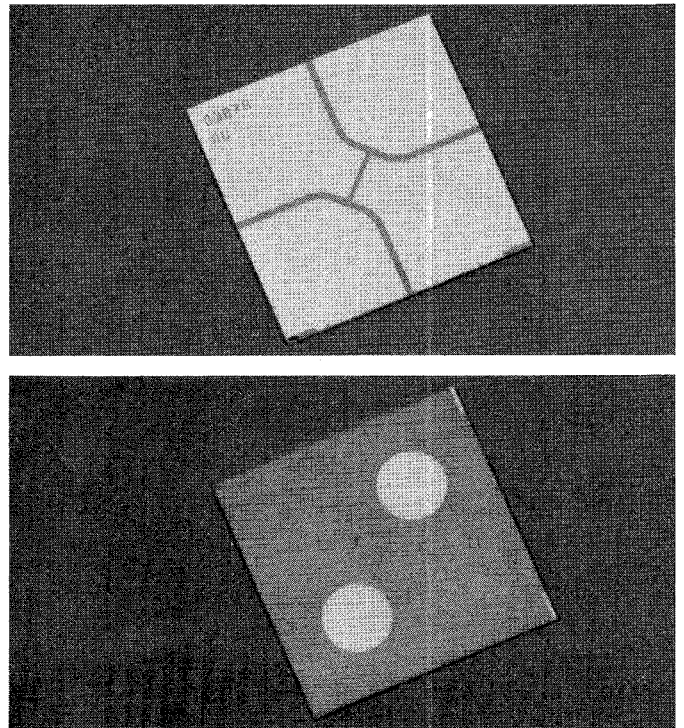

Fig. 4. Implemented sample coupler No. 1 on a 1 in \times 1 in Al_2O_3 ceramic substrate (upper side, bottom side).

TABLE I
DATA OF THE FOUR IMPLEMENTED COUPLERS

coupler	s in mm	measured $a_{31}(f_c)$ in dB	? $Z_0 = \sqrt{Z_M Z_S}$
1	0.036	3.5	yes
2	0.052	3.7	no
3	0.087	4.0	no
4	0.140	4.5	no

$a = 5$ mm	$\epsilon_r = 9.8 \pm 3 \%$
$b = 0.5$ mm	$h = 0.635$ mm (25 mil)
$w_p = 0.62$ mm	$D = 7$ mm
$w = 0.42$ mm	$Z_0 = 50 \Omega$

arise. First, at what position should the reference planes T_1 , T_2 be placed? And second, which definition should be chosen for computing the characteristic impedances Z_S and Z_M ? The answers can be obtained by comparing the theoretical with the measured frequency responses.

For the first question, four tentative positions of the reference plane, described by the distance d between T_1 (or T_2) and the outer edge of the conductor of the feeding

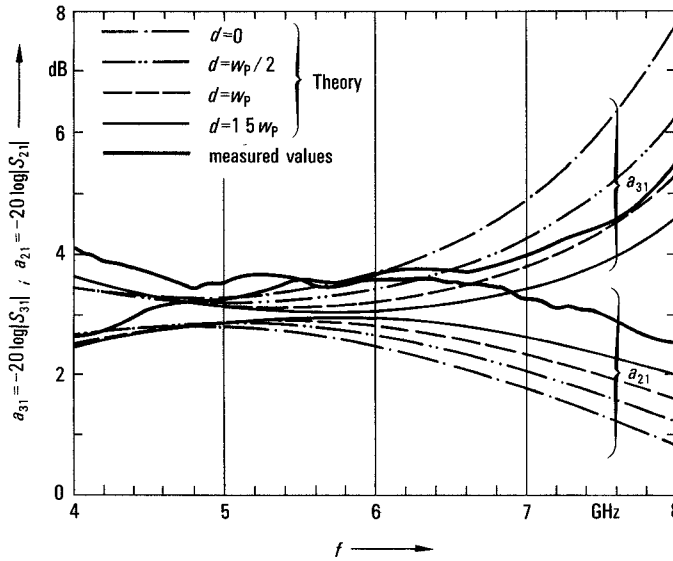

Fig. 5. Coupler 1 ($s = 0.036$ mm). Comparison of measurements $a_{21}(f)$, $a_{31}(f)$ with the theoretical values for $Z_S = Z_S^{(UI)}$ and various positions d of the reference planes T_1, T_2 (whereby $Z_M = Z_M^{(PI)}$).

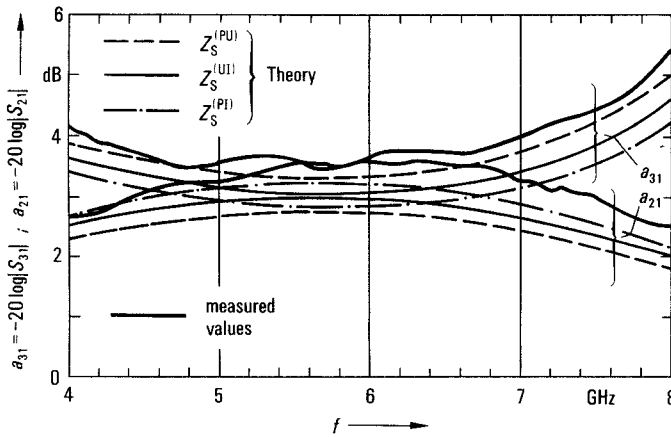

Fig. 6. Coupler 1 ($s = 0.036$ mm). Comparison of measurements $a_{21}(f)$, $a_{31}(f)$ with the theoretical values for reference planes T_1, T_2 with $d = 1.5 w_p$ for three different definitions of the slot-line characteristic impedance Z_S (whereby $Z_M = Z_M^{(PI)}$).

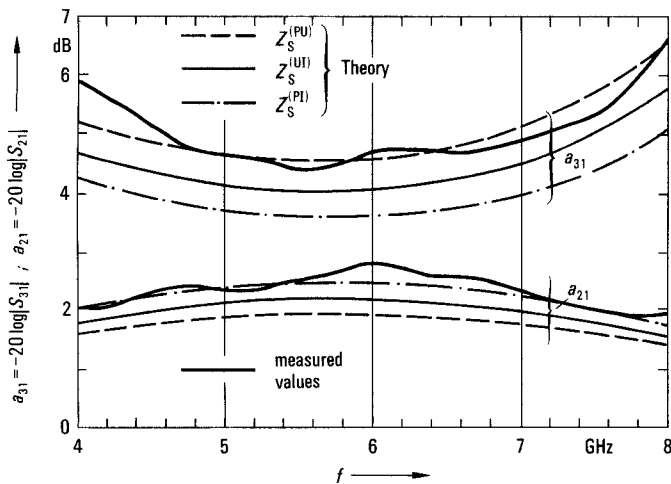

Fig. 7. Coupler 4 ($s = 0.140$ mm). Comparison of measurements $a_{21}(f)$, $a_{31}(f)$ with the theoretical values for reference planes T_1, T_2 with $d = 1.5 w_p$ for three different definitions of the slot-line characteristic impedance Z_S (whereby $Z_M = Z_M^{(PI)}$).

TABLE II
FOUR DIFFERENT TENTATIVE REFERENCE PLANE LOCATIONS d
TOGETHER WITH THE ASSOCIATED l AND l_S FOR THE THEORETICAL
ANALYSIS OF THE COUPLERS AS LISTED IN TABLE I
($w, h, s, a, b, w_p, \epsilon_r$ AS IN TABLE I)

d	l in mm	l_S in mm
0	6.24	0.5
$w_p/2$	5.62	0.81
w_p	5.0	1.12
$1.5 w_p$	4.38	1.43

microstrip line, were investigated as per Table II, viz., $d = 0$ (outer edge), $d = w_p/2$ (middle line), $d = w_p$ (inner edge), $d = 1.5 w_p$ ($w_p/2$ within the inner edges). Corresponding values of the effective length l of the coupling section are shown in Table II as well.

For the second question, three definitions were investigated for Z_S and Z_M : $Z^{(PU)} = U^2/(2P)$, $Z^{(UI)} = U/I$, and $Z^{(PI)} = 2P/I^2$, where P denotes the power transported in the direction of propagation of the mode, I denotes the longitudinal current on one of the two electrodes of the slot line or the strip conductor of the microstrip transmission line, and U denotes the voltage over the slot in the slot line or the voltage between the center of the strip conductor of the microstrip line and ground. The conversion formula is

$$Z^{(PI)} = [Z^{(UI)}]^2 / Z^{(PU)}.$$

The slot-line parameters K_S , $Z_S^{(PU)}$, and $Z_S^{(UI)}$ were computed, under the simplifying assumption of $w = 0$ (standard slot line), by the variational method of Pregla and Pintzos [6] as well as by the method described by Siegl [8] from the cross-sectional dimensions s, h (Fig. 1(b)), the substrate dielectric constant ϵ_r , and the frequency f . Section II shows that the error introduced by the approximation $w = 0$ is, for Z_S and K_S , < 3 percent. The microstrip-line parameters K_M , $Z_M^{(UI)}$, and $Z_M^{(PI)}$ were computed under the simplifying assumption $s = 0$ (standard microstrip transmission line) by the dynamic method of Kowalski and Pregla [3]. As noted in Section II, the error introduced in Z_M and K_M by the approximation $s = 0$ is < 0.3 percent. The results are listed in Table III. Linear interpolation is possible with good approximation (error < 0.5 percent) between 4 GHz and 6 GHz and between 6 GHz and 8 GHz.

We shall first consider the 3-dB coupler 1, which is matched to $Z_0 = 50 \Omega$, on the basis of Figs. 5 and 6. In Fig. 5, the four positions of the reference planes T_1 and T_2 , as per Table II, were used to calculate theoretical values of $a_{21}(f)$ and $a_{31}(f)$. It can be seen that the closest agreement with the measured frequency responses occurs for the reference plane positions defined by $d = 1.5 w_p$, which can be alternatively expressed by $l = a - w_p$. Thus T_1, T_2 are located approximately $w_p/2$ within the inner edges of the feeding lines of width w_p . Larger values of l result in

TABLE III
COUPLING SECTION PARAMETERS FOR THE THEORETICAL ANALYSIS
OF THE IMPLEMENTED COUPLERS AS LISTED IN TABLE I

coupler	f in GHz	K_S	$Z_S^{(PU)}$ in Ω	$Z_S^{(UI)}$ in Ω	$Z_S^{(PI)}$ in Ω
1	4	3.93	47.6	43.9	40.5
	6	4.14	49.5	45.7	42.3
	8	4.29	50.9	47.0	43.3
2	4	3.85	50.8	46.7	42.8
	6	4.06	52.9	48.7	44.8
	8	4.21	54.6	50.1	45.9
3	4	3.69	56.8	51.6	47.0
	6	3.92	59.4	54.2	49.4
	8	4.08	61.5	55.9	50.8
4	4	3.53	63.3	57.0	51.3
	6	3.76	66.5	60.1	54.3
	8	3.94	69.1	62.2	56.0

coupler	f in GHz	K_M	$Z_M^{(PU)}$ in Ω	$Z_M^{(UI)}$ in Ω	$Z_M^{(PI)}$ in Ω
1, 2, 3, 4	4	6.46	60.4	59.9	59.4
	6	6.52	61.4	60.4	59.4
	8	6.59	62.6	61.1	59.6

frequency responses that deviate more sharply from the measurements.

In Fig. 6 the theoretical responses for $a_{21}(f)$ and $a_{31}(f)$ were calculated using the three Z_S definitions, as per Table III, and the position $d = 1.5 w_p$ of the reference planes. For the microstrip mode, we used the definition $Z_M^{(PI)}$. The difference between the three Z_M definitions is below 5 percent and, in the first approximation, negligible. Also negligible is the terminal capacitance of the slot-line open circuits. When $Z_S^{(PI)}$ is used, the theoretical response for $a_{21}(f)$ almost coincides with the measured response of the coupling section without feeding lines, which is obtained by subtracting the 0.1 dB attributable to the feeding lines from the values plotted in Fig. 6, although theory should yield lower values due to the dissipative losses not being taken into account. When $Z_S^{(PU)}$ is used, the same applies for the responses of $a_{31}(f)$. Only when $Z_S^{(UI)}$ is used are the computed values of $a_{21}(f)$ and $a_{31}(f)$ an average of 0.4 dB below the measurements of the coupling section without feeding lines. This difference is attributed to the ohmic and dielectric losses and the radiation loss at discon-

tinuities that are not taken into account in the theory. Thus, the definition $Z_S^{(UI)}$ is the more preferable one for the coupler design.

Also measured were the reflection coefficient S_{11} and the directivity $D = a_{41} - a_{31}$ of the matched 3-dB coupler 1. For $4 \text{ GHz} < f < 8 \text{ GHz}$, there resulted $|S_{11}| < 0.1$ and $D > 20 \text{ dB}$, with a reflection coefficient of < 5 percent for every transition between the microstrip line and the coaxial lines of the test fixture included.

The choice of the reference plane position and of the slot-line impedance definition obtained for coupler 1 also applies to coupler 4 with a larger slot width $s = 0.14 \text{ mm}$, as can be seen from Fig. 7 and to couplers 2 and 3 with intermediate slot widths $s = 0.052 \text{ mm}$ and $s = 0.087 \text{ mm}$. The plots of the values for the latter two couplers are not given here because they correspond to those for couplers 1 and 4.

As to the accuracy of the curves in Figs. 5–7, the following information should be added here. Measurements of the substrate thickness h over the whole substrate resulted in maximum deviation of $8 \mu\text{m}$ from the nominal value of 0.635 mm , which keeps the change in Z_S and Z_M below 0.5 percent and that of K_S and K_M below 0.1 percent; also, the dielectric-constant tolerance, $\Delta\epsilon_r/\epsilon_r < 3$ percent, results in a change of < 2 percent for Z_S , Z_M , K_S , and K_M . Thus the total maximum error for Z_S and Z_M of 2.5 percent is noticeably smaller than the typical difference of 8 to 20 percent between the various Z_S definitions. Similarly, the possible frequency shift of < 1 percent for the theoretical curves due to tolerances in ϵ_r and h is noticeably smaller than the center-frequency shift of 8 to 30 percent caused by different reference plane positions $d = 0$ to $1.5 w_p$. The measurements were performed with an automatic model HP 8542A network analyzer with phase-locked signal source and computer-aided error correction, where the error in attenuation measurement is $< 0.15 \text{ dB}$, including the mismatch error at the transitions of the test fixture.

IV. THEORETICAL PROPERTIES OF VARIOUS COMPENSATED AND UNCOMPENSATED 3-dB COUPLERS

To give an idea of the realizable coupler properties, the theoretical frequency dependent scattering parameters S_{ij} of microstrip-slot couplers with $a_c = 3 \text{ dB}$ and $Z_0 = 50 \Omega$ on 0.635-mm (25 mil) thick Al_2O_3 ceramic substrate ($\epsilon_r = 9.8$) were computed using the analytical method presented in Part I. Since Section III indicates the voltage-current definition $Z_S^{(UI)}$ for the characteristic slot-line impedance as the best choice, this definition was adopted. The parameters $Z_M = Z_M^{(PI)}$, K_M , $Z_S^{(UI)}$, K_S needed for the calculation of S_{ij} were computed by means of methods described in [3] and [6], which imply the use of the approximations of the standard microstrip line and the standard slot line described in Section II.

Three uncompensated couplers ($l_s = 0$) are investigated at the three center frequencies $f_M = 2 \text{ GHz}$, 5 GHz , and 10 GHz . Using (18) and (19) in Part I, $Z_M = 60.35 \Omega$, $Z_S = 41.4$

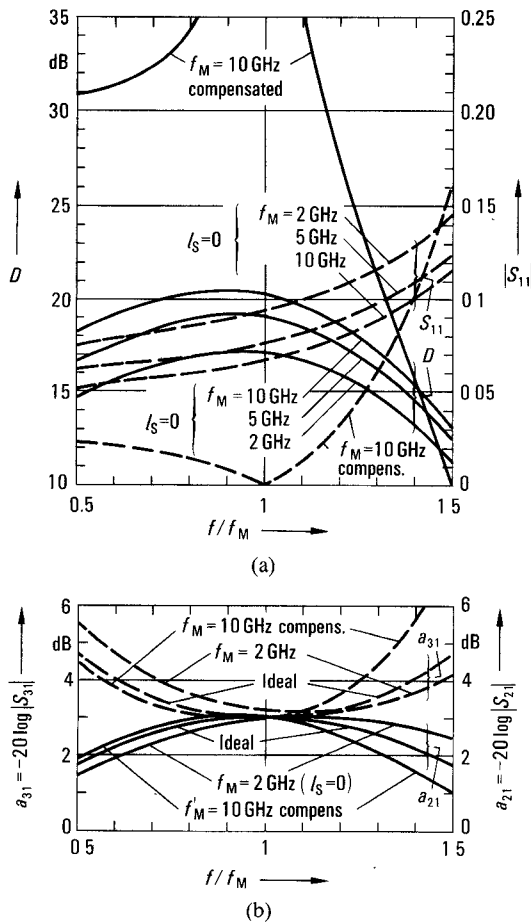

Fig. 8. Theoretical scattering parameters of three uncompensated ($f_M = 2$ GHz, 5 GHz, and 10 GHz) and one compensated 3-dB microstrip-slot coupler ($f_M = 10$ GHz) on Al_2O_3 ceramic substrates ($\epsilon_r = 9.8$, $h = 0.635$ mm = 25 mil), $Z_0 = 50 \Omega$. (a) Directivity D and reflection coefficient S_{11} . (b) Transmission loss a_{21} and coupling loss a_{31} .

TABLE IV
DATA OF THE THEORETICALLY ANALYZED COUPLERS
(UNCOMPENSATED)

f_M in GHz	2	5	10
$K_M(f_M)$	6.39	6.47	6.66
$K_S(f_M)$	3.48	4.14	4.55
w in mm	0.40	0.40	0.41
s in mm	0.045	0.022	0.015
l in mm	14.83	5.90	2.91

Ω are obtained for all three. All further parameters are listed in Table IV. The length l was computed from the microstrip center frequency f_M using (25) of Part I. The parameters S_{ij} are shown in Fig. 8. The directivity $D = -20 \log |S_{41}/S_{31}|$ and the reflection coefficient S_{11} are seen to improve with rising f_M due to $K_S (< K_M)$ steadily approaching K_M as it rises more sharply with the frequency. The a_{31} , a_{21} for $f_M = 5$ GHz and 10 GHz almost coincide with those for $f_M = 2$ GHz.

Let the coupler for $f_M = 10$ GHz now be provided with compensation lines ($l_s > 0$) at the two ends of the coupling section to assure exact compensation at $f_{co} = f_M = 10$ GHz, i.e., $D(f_M) = \infty$, $S_{11}(f_M) = 0$. For compensation it is necessary for $Z_S = 41.4 \Omega$ to be raised to $Z_S^* = Z_S^* 43.0 \Omega$ according to (29) in Part I and for $l_s = 0.61$ mm to be chosen according to (30) in Part I. As an approximation, assume $Z_S^* = Z_S^* = 43.0 \Omega$ and $K_S^* = K_S = 4.55$ and K_S to remain unchanged due to the slight increase of Z_S to Z_S^* . The scattering parameters $S_{ij}(f)$ computed for this compensated coupler according to Part I are likewise shown in Fig. 8. It will be noted that Z_S^* appears in the equations in place of Z_S . Fig. 8 shows a sharp improvement in both the directivity D and the reflection coefficient S_{11} , especially for $f < f_M$. The high directivity often measured (e.g., in [9]) on microstrip-slot couplers with a slot extending as far as the outer edge of the feed line ($b = 0$ in Fig. 1) is attributable to this coupler already being partially compensated.

V. CONCLUSIONS

Comparison of the measurements on couplers with various slot widths realized on Al_2O_3 ceramic substrates with the result yielded by theoretical analyses show close agreement under the following conditions. First, reference planes for the ends of the coupling section must lie by about half the width of the transmission lines within the inner edges of the latter for couplers with center frequencies in the region of 5 GHz. Second, the characteristic impedance $Z_S^{(UI)}$ defined by the current and voltage must be used for the slot line. Third, in order to take account of the transmission line loss the theoretical curves must be displaced by a fixed value — here approximately 0.4 dB — towards higher attenuations. Estimates have shown the theories of the standard microstrip transmission line and the standard slot line to be sufficient for the practical designing of couplers.

ACKNOWLEDGMENT

The authors wish to record their thanks to F. Koppehele for facilitating the project as well as offering his support.

REFERENCES

- [1] H. A. Wheeler, "Transmission-line properties of parallel strips separated by a dielectric sheet," *IEEE Trans. Microwave Theory Tech.*, vol. MTT-13, pp. 172–185, Mar. 1965.
- [2] T. G. Bryant and J. A. Weiss, "Parameters of microstrip transmission line and of coupled pairs of microstrip lines," *IEEE Trans. Microwave Theory Tech.*, vol. MTT-16, pp. 1021–1027, Dec. 1968.
- [3] G. Kowalski and R. Pregla, "Dispersion characteristics of single and coupled microstrips," *Arch. Elek. Übertragung.*, vol. 26, pp. 276–280, June 1972.
- [4] S. B. Cohn, "Slot line on a dielectric substrate," *IEEE Trans. Microwave Theory Tech.*, vol. MTT-17, pp. 768–778, Oct. 1969.
- [5] E. A. Mariani, C. P. Heinzman, J. P. Agrios, and S. B. Cohn, "Slot line characteristics," *IEEE Trans. Microwave Theory Tech.* vol. MTT-17, pp. 1091–1096, Dec. 1969.
- [6] R. Pregla and S. G. Pmtzos, "Determination of the propagation constants in coupled microslots by a variational method," in *Proc. of the 5th Coll. on Microwave Comm.*, vol. IV, Budapest 1974, pp. MT 491–MT 500.
- [7] U. Schulz and R. Pregla, "A new technique for the analysis of the dispersion characteristics of planar waveguides," *Arch. Elek. Übertragung.*, vol. 34, pp. 169–173, Apr. 1980.

- [8] J. Siegl, "Numerische Berechnung der Grundwelle und der höheren Wellentypen auf einer Schlitzleitung mit rechteckigem Schirm und endlicher Metallisierungsdicke." Thesis Techn. Universität Berlin, 1978.
- [9] J. A. Garcia, "A wide-band quadrature hybrid coupler," *IEEE Trans. Microwave Theory Tech.*, vol. MTT-19, pp. 660-661, July 1971.

such as mixers, amplifiers, phase shifters in radar and communication equipment, and for computer-aided design methods for microwave integrated circuits.



Reinmut K. Hoffmann, born at Hof/Saale, Germany, on July 9, 1942, received the Dipl.-Ing. degree in electrical engineering from the Technical University in Munich, Germany, in 1967.

In October 1967 he joined the Central Communications Laboratories of Siemens AG in Munich, where he was engaged in the development of microwave integrated-circuit components and in research in microstrip transmission lines and couplers. Since 1973 he has been head of a development group for MIC-components,

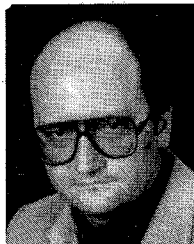

Johann Siegl, born on June 5, 1947, received the Ing. (grad.) degree from the Ingenieurschule München, Germany in 1970 and the Dipl.-Ing. degree from the Technical University Berlin in 1973.

From 1973 to 1978, while at the Institute of High-Frequency Engineering, he was a Research and Teaching Assistant at the Technical University in Berlin. He has been engaged in investigations into the properties of slot lines and fin lines in the millimeter-wave frequency range. In 1978

he received the Dr.-Ing. degree from the Technical University in Berlin.

At the beginning of 1979 he joined the Communications Group at Siemens AG in Munich, his first assignment being the computer-aided design of microwave integrated circuits. Since 1981 he has been involved in the development of digital transmission systems.

A Synthesis Procedure for Designing 90° Directional Couplers with a Large Number of Sections

BENGT ULRIKSSON, STUDENT MEMBER, IEEE

Abstract—A synthesis method for designing symmetrical directional couplers with an arbitrary realizable coupling is described. The method is based on a transformation of the coupling to the time domain, where the couplings of the different sections are easily identified. The fundamental operation of the method is the Fast Fourier Transform, which makes it very efficient in computer time and memory requirements. The method is illustrated by the design of a 8.34 ± 0.3 -dB equal-ripple coupler with 201 sections.

I. INTRODUCTION

THE DESIGN OF multisection directional couplers is usually based on an equivalent stepped impedance filter, where the reflected power is equivalent to the coupling [1]. The problem then consists of two parts. The first

part is the approximation, which gives the magnitude of a realizable reflection coefficient for the equivalent stepped impedance filter. The specified reflection coefficient is optimum with respect to some requirement (for example, equal ripple).

The second part is the synthesis, where the impedances are computed from the magnitude of the reflection coefficient. The most well-known synthesis procedure is the insertion-loss method [2]. The main problem with this method is the computation of the poles and the zeros of the reflection coefficient. It has been found that the poles and the zeros cannot be computed for couplers with more than 17 to 19 sections because of the limited accuracy of the iterative procedure in this step [3].

Another synthesis method is a straight-forward optimization. Unfortunately, an optimization has several problems. It puts very heavy demands on the computer, and the

Manuscript received December 15, 1981; revised March 10, 1982.
The author is with the Division of Network Theory, Chalmers University of Technology, S-412 Gothenburg, Sweden.